

THE PROPERTY OF THE DRAWING IS ESTABLISHED BY LAW. IT IS FORBIDDEN TO PRODUCE OR SHOW IT TO THIRD PART. WITHOUT A WRITTEN AGREEMENT.

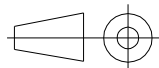
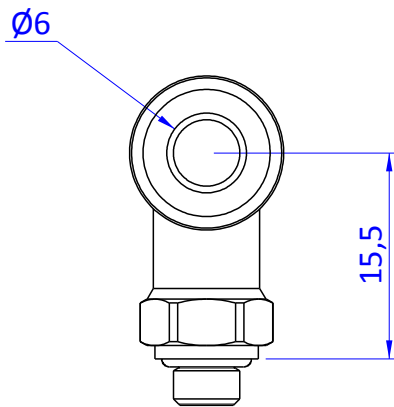
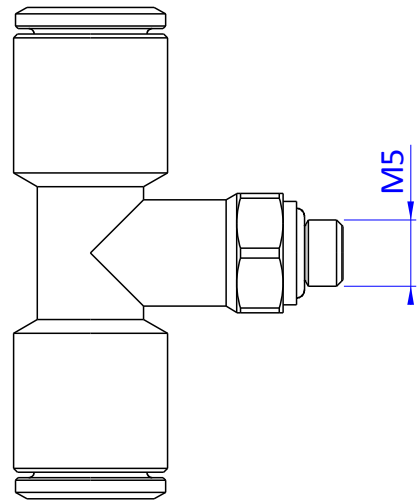
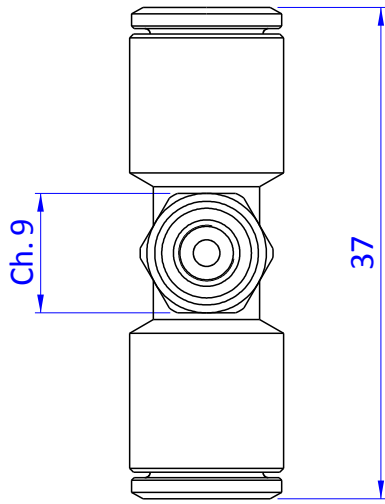
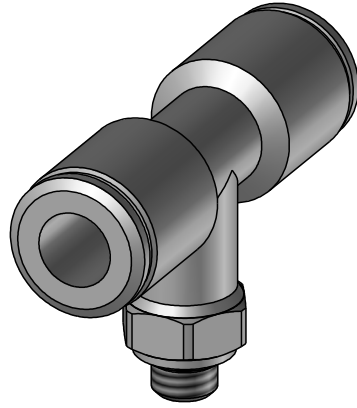

DESIGNED FROM		REVIEW
FPS Automation		A
DATE	WEIGHT	
18/07/2019	0.009Kg	
CODE		
CA.12.05.031		

Format	A4
UNI 936-76	

GENERAL TOLERANCE	DESCRIPTION
UNI - ISO 2768	CA.12.05.031
CLASSE f	